

SkySweep Technologies

Global Solutions for High Speed
HF/VHF/UHF DATA RADIO



SkySweep Data Radio System
Public Safety and Security (PSS)

Secure voice

Content

<u>What SkySweep Data Radio system for Public Safety and Security (PSS) with secure voice can offer.....</u>	<u>Page 3</u>
<u>General overview of SkySweep Data Radio system for secure data and voice.....</u>	<u>Page 4</u>
<u>Secure voice general system overview.....</u>	<u>Page 5</u>
<u>Description of the Data Radio for secure data and voice.....</u>	<u>Page 6</u>
<u>Base Stations for secure data and voice.....</u>	<u>Page 7</u>
<u>Mobile Stations for secure data and voice.....</u>	<u>Page 7</u>
<u>Overview of the SkySweep PSS Data Radio product for secure data and voice.....</u>	<u>Page 8</u>
<u>Specifications of SkySweep PSS HF/VHF/UHF Data Radios for secure data and voice.....</u>	<u>Page 10</u>
<u>Contact.....</u>	<u>Page 11</u>



„Are you searching for a high speed DATA RADIO solution for secure data and voice...?
 ...or a special data application?“

SkySweep Technologies can offer not only a simple data radio which are offered by many vendors without proper customer support. SkySweep can provide even more: unique high data rate and a high coverage data radio system.

Each of the SkySweep DATA RADIO variants offers

- ➔ **Embedded Windows™ computer**
- ➔ **Unique software applications**
- ➔ **High speed modems**
- ➔ **Standard Protocols**
- ➔ **Transceiver**
- ➔ **All of these in one high integrated data radio device. No need for expensive computers nor modems!**



Normally there is one of the four possible basic situations:

1. No existing radio system => choose SkySweep Data Radios.
2. Existing voice radio system => SkySweep will provide add on high speed Data Radios.
3. Existing voice radios which need data solutions => SkySweep will provide the SkyCR-1 controller unit for data.
4. No existing secure voice / no backup-voice / no secure data solutions => choose SkySweep Data Radios for secure data and voice.

What is your basic situation?

„Learn more about the many capabilities of the SkySweep system. Build up your secure PSS VHF/UHF DATA RADIO network for secure data and voice now. The possibilities will inspire you.“



A simplified topview block diagram of a **SkySweep Data Radio** supporting one high speed data channel is shown below. SkySweep Data Radios consist of a Windows™ pc controller unit, system software, modems and a radio transceiver.

The **SkySweep Data Radio** provides several flexible and standardized interfaces. It is very easy to install: Just connect the cables and start to operate.

SkySweep Data Radio block diagram:

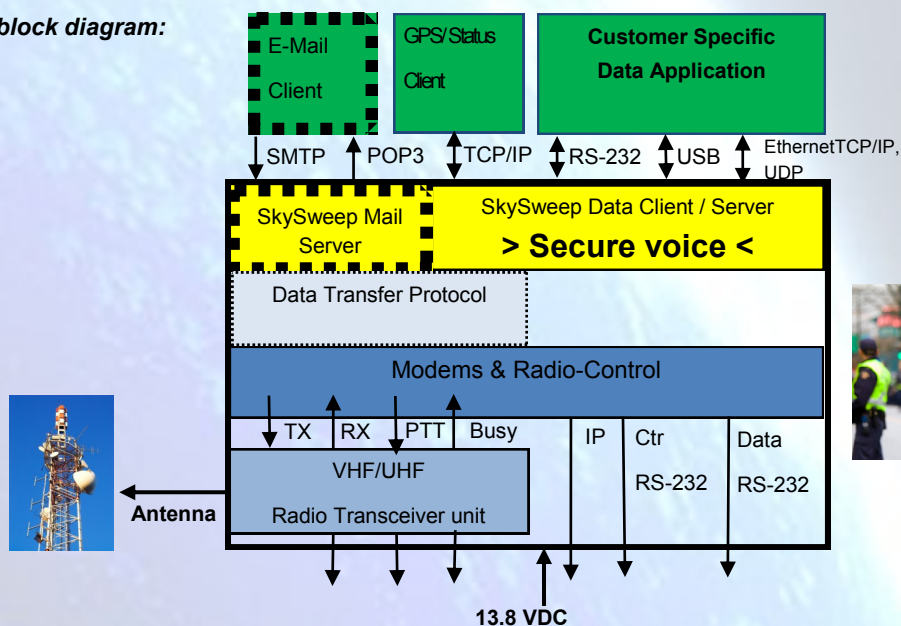

„What are your requirements? Let's define your Data Radio system now.“

„In today's world a secure and independent reliable Data Radio network is valuable.“

Note: secure voice capability is optionally available to the SkySweep Data Radios.

The SkySweep Data Radio system is state-of-the-art OFDM modem based solution for high speed (up to 100 kbit/s) HF/VHF/UHF radio data communications.

Its main applications are: IP or RS-232 based data connection services, GPS based tracking, E-Mail, video, instant messaging (chat), and encrypted secure voice for HF/VHF/UHF (*). The contents of a product delivery may range from a software only delivery to complete customer specific turn-key system deliveries. (*Video, instant messaging (chat), secure voice: available in 2012)

The SkySweep Data Radio system adapts as well to a small few local stationary or mobile stations network as to systems of hundreds of stations.

The SkySweep Data Radio system can also be used with existing voice communications networks such as analog HF/ VHF/ UHF or digital (TETRA, P25, DMR, dPMR, TETRAPOL, etc) networks.

Why to choose a SkySweep Data Radio system?

One reason of many: Take data load away from voice systems.

Most PMR radio systems are optimised for voice but typically don't have much extra capacity reserved for data. This means that, when the amount of data in the net increases, the quality of voice service decreases. Typically current voice systems don't offer any solutions for advanced state-of-the-art highspeed data or mobile data transmission.

The SkySweep Data Radio system and SkySweep application interfaces are based on international standards.

Additionally the SkySweep system is compatible with NATO communication systems and provides encrypted and secure transmissions. The SkySweep Data Radio HF-system is STANAG 5066 compliant. Customer's own applications and existing system interfaces can connect to these well known standards without any problems. This flexibility offers very cost efficient possibilities.

Just two examples of the system key benefits :

- **Cost efficient system.** The system is based on the IP network architecture and high coverage base stations. The SkySweep Data Radio can be used to run its own and customer specific applications => no extra computer is needed for applications.



- **Low power consumption.** The mobile and Base Station transmitters are switched on only, when there is something to send. The system can be powered independently by solar energy or a very small fuel cell. Long battery based operating times are ideal for emergency systems, etc. There are no control channels needing continuous transmit power.

The SkySweep Data Radio system provides high speed and very cost efficient data communication on VHF/UHF frequency bands. It is also possible to extend the coverage with SkySweep HF Data Radios.

The SkySweep Data Radio has different variants for:

- **VHF or UHF** for medium coverage with high data rate
- **or HF** for high coverage over long distances with a medium data rate
- **Frequency channel bandwidth**
- **System features**

The SkySweep Data Radio system can combine the benefits of VHF/UHF Data Radio systems to the benefits of HF Data Radio systems.

SkySweep HF/VHF/UHF secure voice system

Secure voice general system overview

The SkySweep HF/VHF/UHF Base Stations with secure voice offer data and encrypted voice gateway services between air interface (mobile stations) and IP-network data services. SkyDR-1 Base Station Data Radios with secure voice variants provide:

- IP based interface between radio interface and fixed network

The SkySweep Mobile Stations offer secure data and voice services.

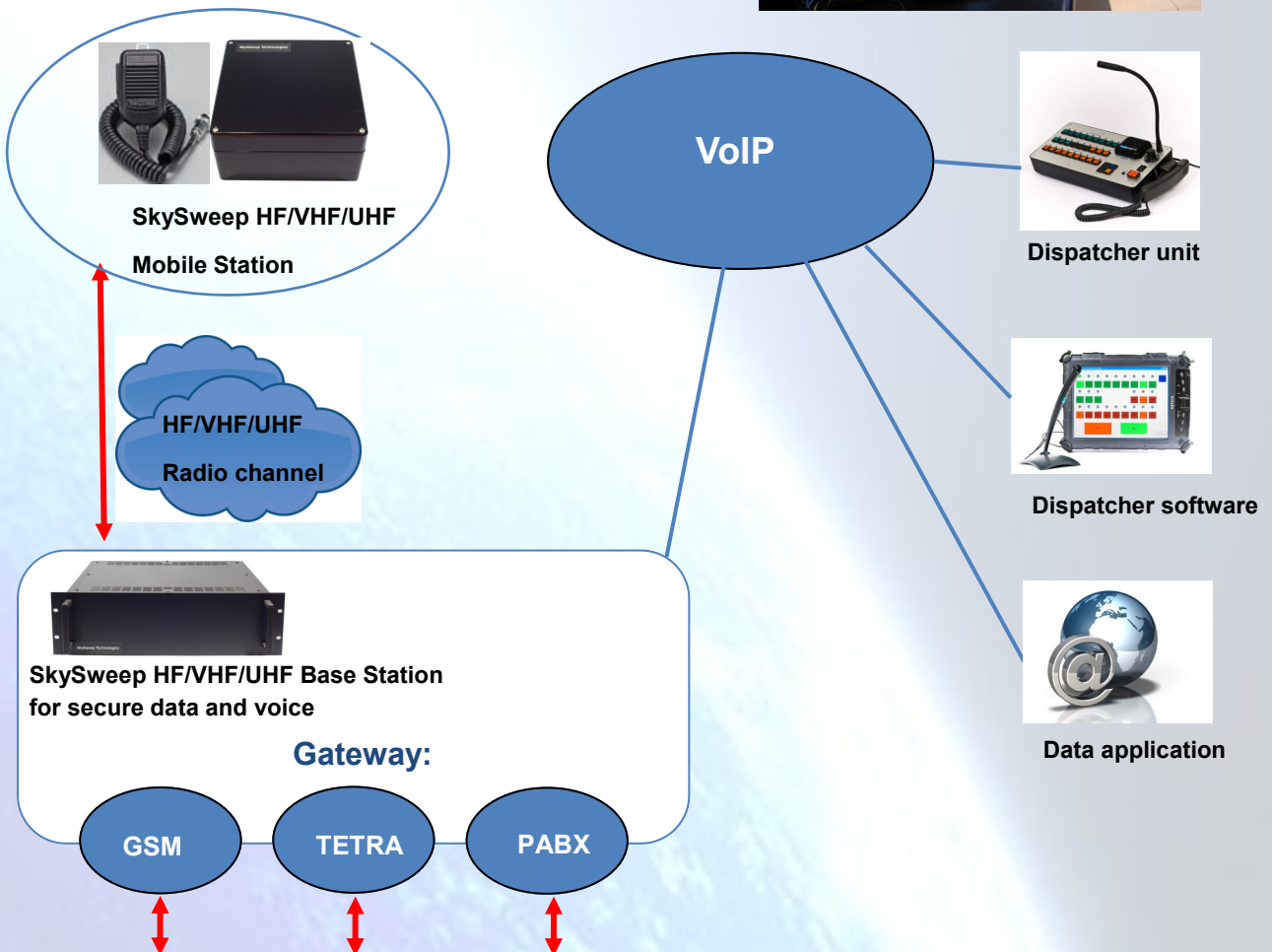
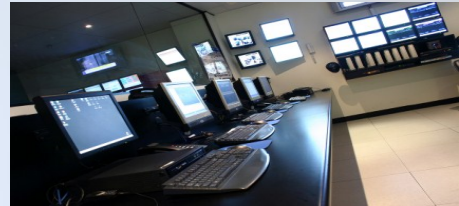

„Make use of the many HF/VHF/UHF based Data Radio communication advantages.“

SkySweep HF/VHF/UHF secure voice system

Description of the Data Radio for secure data and voice

The SkySweep secure voice system solution provides encrypted voice transmissions within the HF/VHF/UHF based radio-network.

The voice signal is sent from the dispatcher to SkySweep Base Stations using an advanced Voice over IP solution.

The base station sends the secure voice to mobile stations.

A huge benefit: SkySweep can combine Data + VoIP which are securely transmitted within an HF/VHF/UHF based radio network.

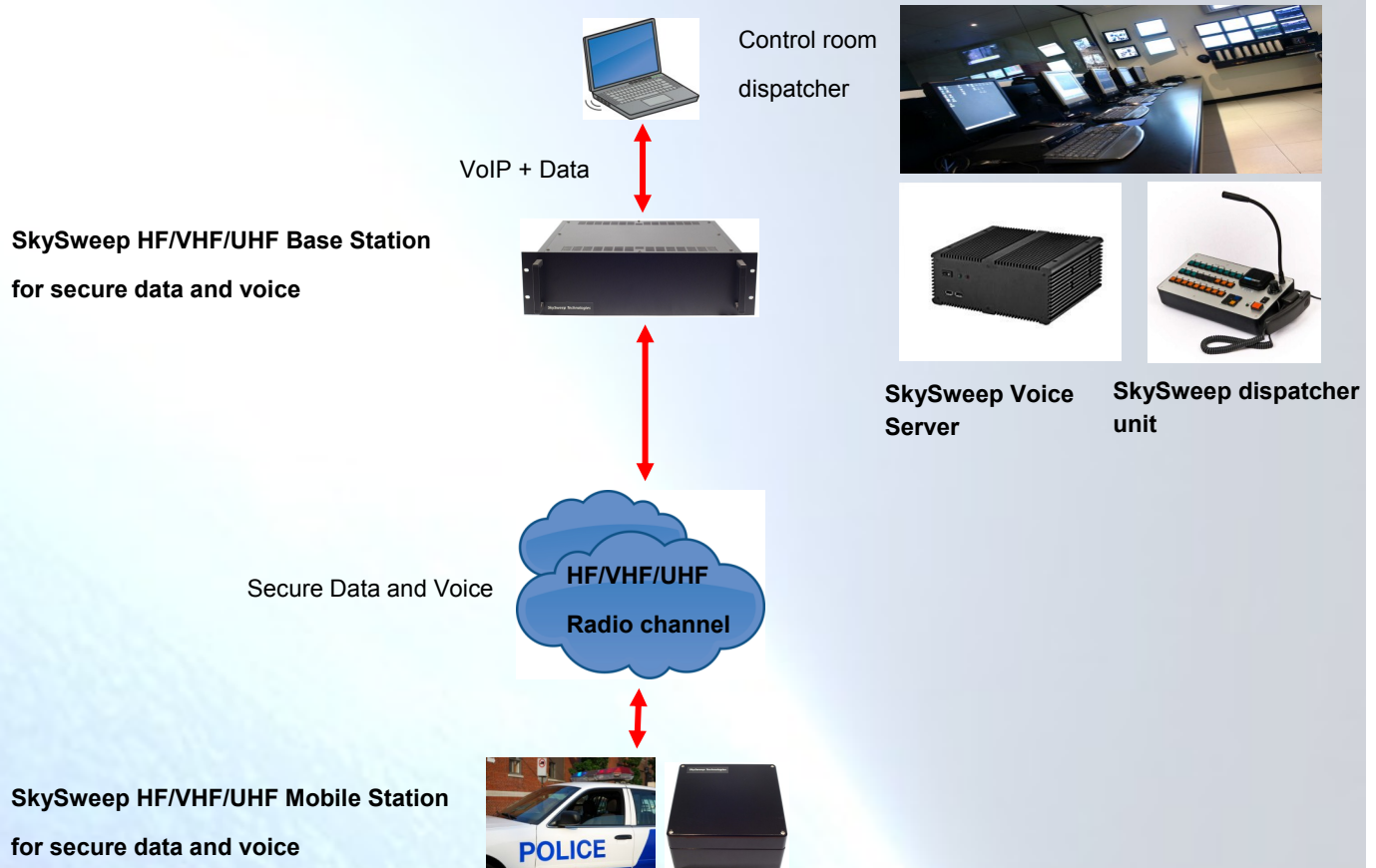

SkySweep voice server:			
Operating system:	Windows™	Networking:	2 x 1000 base T Ethernet WLAN (optional)
CPU :	Intel® Core™ 2 Duo	Power consumption:	20 W
Memory:	2 GB DDR SDRAM (up to 8 GB)	Cooling:	Passive
Storage:	1 x 32 GB SSD disk	Certifications:	CE, FCC Class A
Display Interface:	HDMI / DVI-I / VGA	Mounting:	Desktop, Wall-mount
Data Interfaces:	5 x RS-232 (Male connector) 4 x USB / 4 x DIOs	Temperature / Humidity:	Operating: 0° to 40 °C (HDD), 0° to 50 °C(SSD) Storage: -20° to 80 °C, 0 % - 90 %, non-condensing

Base Stations for secure data and voice

Equipment for secure data and voice

SkySweep dispatcher unit:



SkyDR-1H/V/U **BS** Base Station HF/ VHF/UHF TRX Data Radio, **with secure voice**, 19-inch 3U:



SkySweep dispatcher software:



SkyDR-1V/U **RBS** Base Station HF/ VHF/UHF rugged TRX Data Radio, **with secure voice**, compact aluminium enclosure:



SkySweep voice server:



Mobile Stations for secure data and voice

Equipment for secure data and voice

The SkySweep VHF/UHF Mobile Stations offer various data services to be connected to other Mobile Stations or to fixed IP network through the Base Station.

SkySweep Mobile Station entry solution for secure voice + data:

The SkySweep based Mobile Station for secure data and voice entry solution contains a small size rugged **SkyCR-1R** controller unit, display, GPS receiver, microphone and an existing VHF/UHF transceiver unit. A compatible TRX on request.



The SkyDR-1H/V/U Mobile Station Data Radio for secure data and voice:

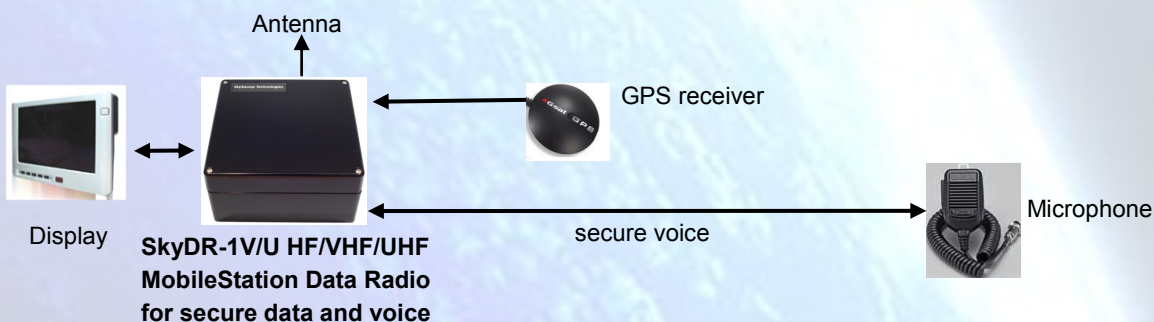

SkyDR-1V/U **RM** Mobile Station rugged TRX VHF/UHF Data Radio, compact rugged aluminium enclosure, GPS-receiver:



SkyDR-1H **RBS** Mobile Station rugged TRX HF Data Radio, compact rugged aluminium enclosure, GPS-receiver:



Overview of the SkySweep PSS Data Radio product variants for secure data and voice

SkySweep VHF TRX Data Radios and Multichannel receivers for VHF 12.5/20/25/50 kHz bandwidth channels:

SkyDR-1VM+Voice > SkyCR-1R controller unit + GPS receiver, mounting kit to be used with existing or new VHF radio.
 SkyDR-1VRM+Voice > Mobile rugged Data Radio station: compact rugged aluminium enclosure, GPS-receiver.
 SkyDR-1VBS+Voice > Base Station Data Radio, 19-inch enclosure.
 SkyDR-1VRBS+Voice > Base Station rugged Data Radio: compact rugged aluminium enclosure.
 SkyRX-1VBS+Voice > MRX-Multicarrier-RX Data Radio up to 25 kHz, 19-inch enclosure, receiving only (*).
 SkyRX-2VBS+Voice > MRX-Multicarrier-RX Data Radio up to 50 kHz, 19-inch enclosure, receiving only (*).

SkySweep UHF TRX Data Radios and Multichannel receivers for UHF 12.5/20/25/50 kHz bandwidth channels:

TRX Data Radios for UHF 12.5/20/25/50 kHz bandwidth channels:
 SkyDR-1UM+Voice > SkyCR-1R controller unit + GPS receiver, mounting kit to be used with existing or new UHF radio.
 SkyDR-1URM+Voice > Mobile rugged Data Radio station: compact rugged aluminium enclosure, GPS-receiver.
 SkyDR-1UBS+Voice > Base Station Data Radio, 19-inch enclosure.
 SkyDR-1URBS+Voice > Base rugged Station Data Radio: compact rugged aluminium enclosure.
 SkyRX-1UBS+Voice > MRX-Multicarrier-RX Data Radio up to 25 kHz, 19-inch enclosure, receiving only (*).
 SkyRX-2UBS+Voice > MRX-Multicarrier-RX Data Radio up to 50 kHz, 19-inch enclosure, receiving only (*).
 *MRX-Multicarrier-RX Data Radios available in 2012

HF TRX Data Radios:

SkyDR-1VM+Voice > SkyCR-1R controller unit + GPS receiver, mounting kit to be used with existing or new HF radio.
 SkyDR-1HRM+Voice > Mobile rugged HF Data Radio station: compact rugged aluminium enclosure, GPS-receiver.
 SkyDR-1HBS+Voice > Base Station HF Data Radio in 19-inch enclosure.
 SkyDR-1HRBS+Voice > Base Station rugged HF Data Radio: compact rugged aluminium enclosure.

VHF TRX	VHF RX	TRX 12.5/20/25/50 kHz	RX 25 kHz	RX 50 kHz	19-inch	R-ALU	MS-MK	GPS	EM	MS	TR	DA	CA	Vi	CH	CR
SkyDR-1VM																
SkyDR-1VRM																
SkyDR-1VBS / RBS					-VBS	-RBS										
	SkyRX-1VBS															
	SkyRX-2VBS															
UHF TRX	UHF RX	TRX 12.5/20/25/50 kHz	RX 25 kHz	RX 50 kHz	19-inch	R-ALU	MS-MK	GPS	EM	MS	TR	DA	CA	Vi	CH	CR
SkyDR-1UM																
SkyDR-1URM																
SkyDR-1UBS / RBS					-UBS	-RBS										
	SkyRX-1UBS															
	SkyRX-2UBS															
HF TRX		TRX 1.6 - 30MHz			19-inch	R-ALU	MS-MK	GPS	EM	MS	TR	DA	CA	Vi	CH	CR
SkyDR-1HRM																
SkyDR-1HBS / RBS					-HBS	-RBS										

Definition of available hardware and applications:

Marked = Currently available

TRX 12.5/20/25/50 kHz	Supported TRX channel bandwidth	MS	Mail server
RX 25kHz / 50kHz	Receiving channel bandwidth up to 25/50kHz	TR	GPS based tracking
19-inch	19inch enclosure	DA	Data Connection Service
R-ALU	compact rugged aluminium enclosure	CA	Customer own applications
MS-MK	Mobile Station mounting-kit for vehicles	Vi	Video (available in 2012)
GPS	GPS receiver	CH	Instant messaging Chat client (available in 2012)
EM	Secure E-mail	CR	Secure voice (available in 2012)

Specifications of SkySweep PSS HF/ VHF/ UHF Data Radio for secure data and voice

SkyDR-1V/U/H M Mobile Station Data Radio solution (single units):

Entry Data Radio + **secure voice**: SkyCR-1R controller unit + existing HF/ VHF or UHF radio, GPS receiver and mounting kit (brackets). Existing radio can be used depending on the radio-model.

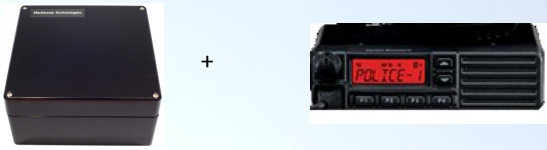

SkyCR-1R controller **Existing HF/ VHF or UHF Radio**

SkyCR-1R controller, rugged aluminium enclosure (L x W x H)	200 x 200 x 80 mm, Weight ~2 kg
---	---------------------------------

- High quality rugged aluminium alloy, black powder coated RAL9005, EMC-gasket (-20° up to +50 °C)
- stainless steel Lid screws, waterproofed IP 66 /IP 67 EN 60529, external mounting brackets

SkyDR-1H/V/U RM / RBS rugged Data Radio for secure data and voice:



Compact rugged aluminium enclosure (L x W x H)	VHF/UHF: 240 x 240 x 120 mm / HF: 480 x 240 x 120 mm
Lid screw position (D x E)	VHF/UHF: 220 mm x 220 mm / HF: 460 x 220 mm
Weight	VHF/UHF: ~4.5 kg HF: ~6 kg

- High quality rugged aluminium alloy
- black powder coated RAL9005
- EMC-gasket (-20° up to +50 °C)
- stainless steel Lid screws
- waterproofed IP 66 /IP 67 EN 60529
- external mounting brackets

SkyDR-1H/V/U/H BS Data Radio for secure data and voice:

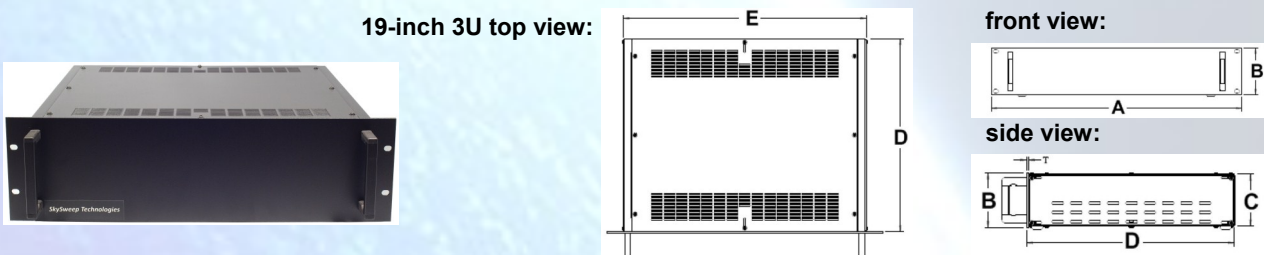

19-inch 3U enclosure (E x D x C)	425 x 425 x 128 mm
Front Panel (A x B)	483 x 133 mm
Weight	~10.8 kg

- Complies with IEC 297, EIA RS-310 C1977, DIN41494
- allows complete compatibility with all 19" standard equipment
- Powder coat finish preceded by 5 stage iron phosphate pretreatment
- High grade cold rolled steel
- Aluminum on front and rear panel
- Conforms to ASTM D610-01/ ASTM B117

SkySweep voice server:



SkySweep voice server, aluminium enclosure (L x W x H)	229.5 x 212 x 78 mm, Weight ~4kg
--	----------------------------------

SkySweep Technologies

Global Solutions for High Speed
HF/VHF/UHF DATA RADIO



**If you have any questions about our products,
please do not hesitate to contact us:**

Web: www.skysweep.com

E-Mail: messenger@skysweep.com

Tel: +358 10 3465180

FAX: +358 10 3465181

Mail: SkySweep Technologies Oy

P.O. Box 6

Fin-02661 Espoo

Street-Address: Linnoitustie 4, Espoo